

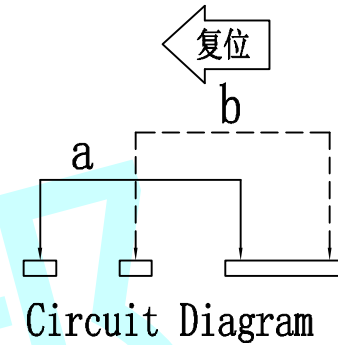

**ROHS**

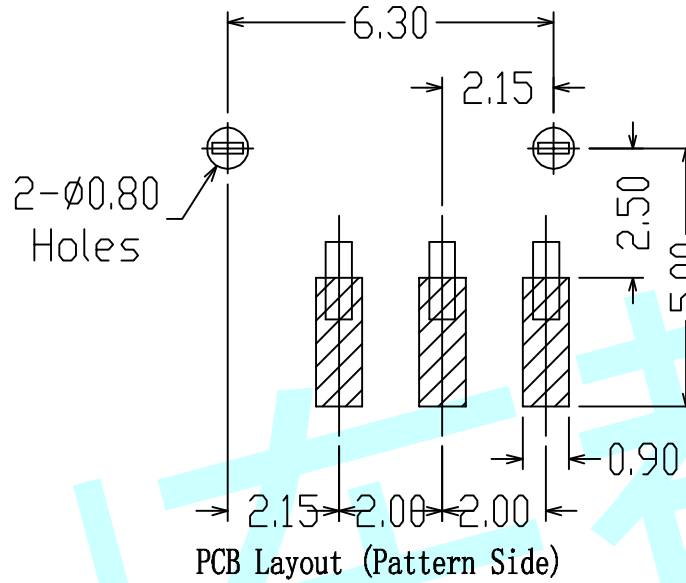

NOTES:  
1. Operating Force :  $150 \pm 100$ gf

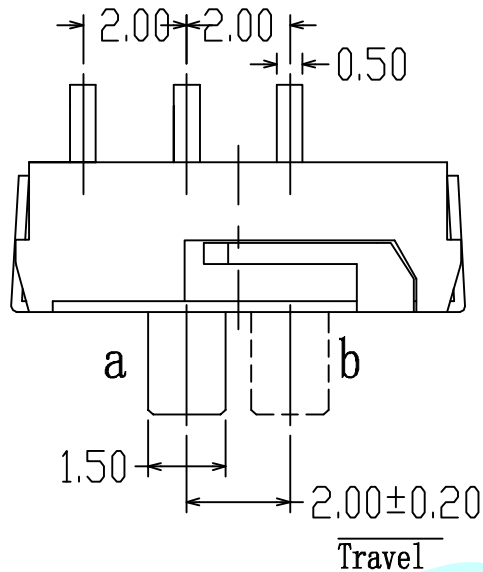
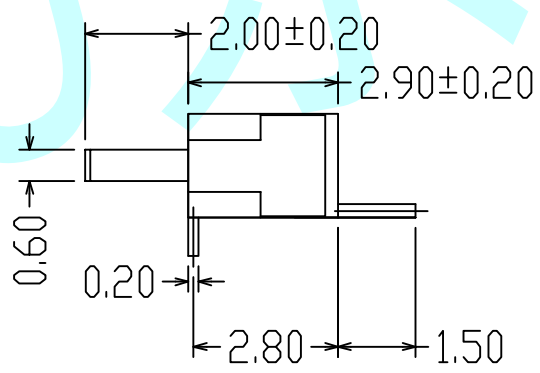
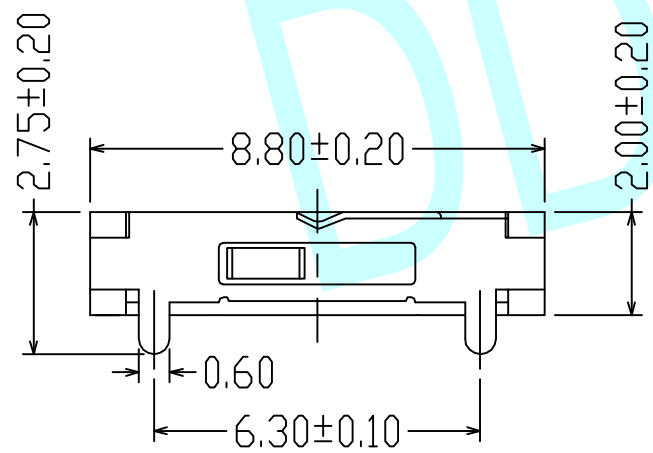

APPROVALS		DATE	<a href="http://www.dongdudz.com">http://www.dongdudz.com</a>		 <b>® 东都电子</b> DONGDU ELECTRONICS
DRAW:	ZRD	2017-12-6	TOLERANCE:	ANGLE:	
CHECKED:	***	***	30 $\geq$	$\pm 0.30$	$\pm 2^\circ$
APPOVALS:	***	***	10 $\sim$ 30	$\pm 0.20$	
			5 $\sim$ 10	$\pm 0.15$	
			$\leq 5$	$\pm 0.10$	
MODEL:	TOGGLE SWITCHES		UNIT :mm	SCALE:1:1	
PART NO:	DDU-1404S		REV:	A	PAGE:1/1