

ROHS

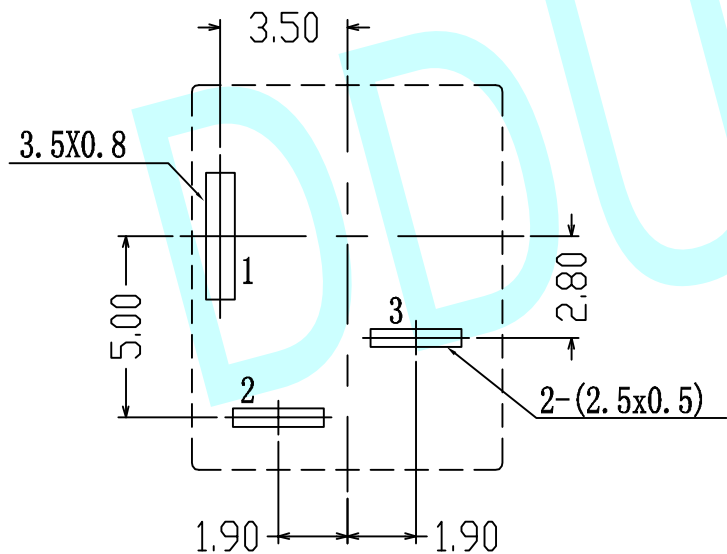

PCB Layout (Copper-Side View)

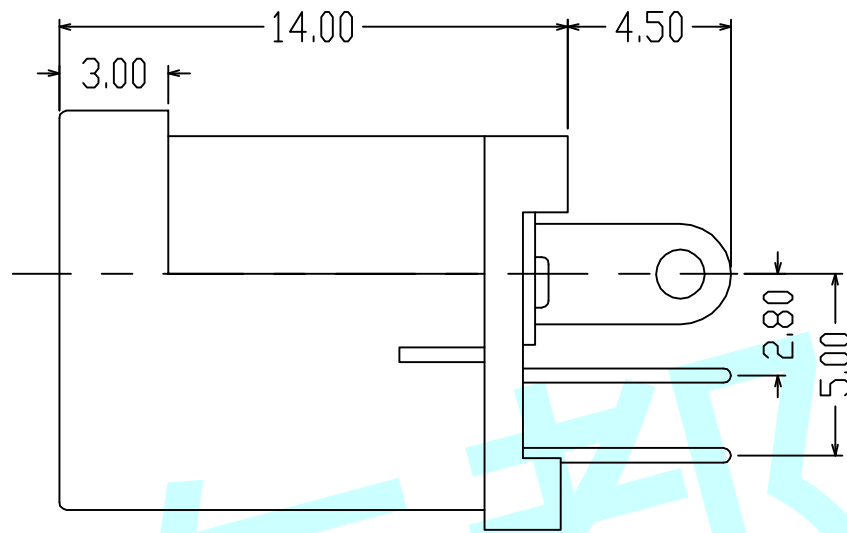
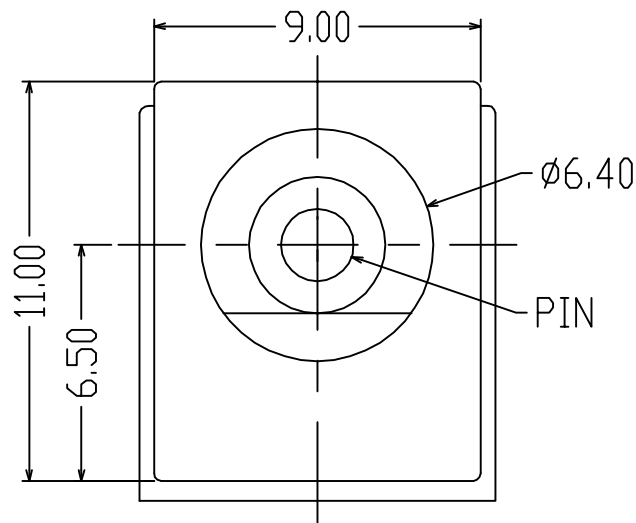
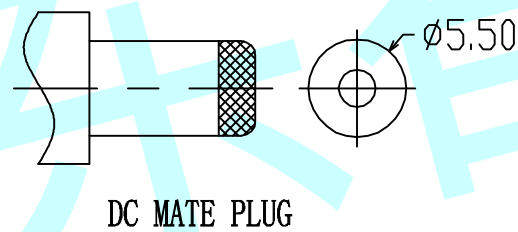

DC MATE PLUG

NOTES:

1. Rating:DC 0.5A 30V
2. Contact Resistance:100mΩ Max
3. Operating temperature:-20℃~70℃
4. Operating force:3-20N
5. Operating Life:5,000cycles

DC-012A-A

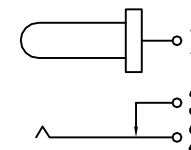

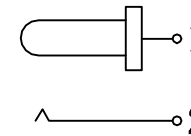

CIRCUIT DIAGRAM

DC-012A-B



CIRCUIT DIAGRAM

APPROVALS		DATE	http://www.dongdudz.com		 东都电子 DONGDU ELECTRONICS
DRAW:	ZRD	22017-12-6	TOLERANCE:	ANGLE:	
CHECKED:	***	***	30° ≥ ±0.30	±2°	
APPOVALS:	***	***	10°~30 ±0.20		
			5°~10 ±0.15		
			≤5 ±0.10		
MODEL:	DC POWER JACK		UNIT :mm	SCALE:1:1	
PART NO:	DC-012A		REV:	A	

PIN	ø2.00	ø2.35	ø2.50
-----	-------	-------	-------