

ROHS

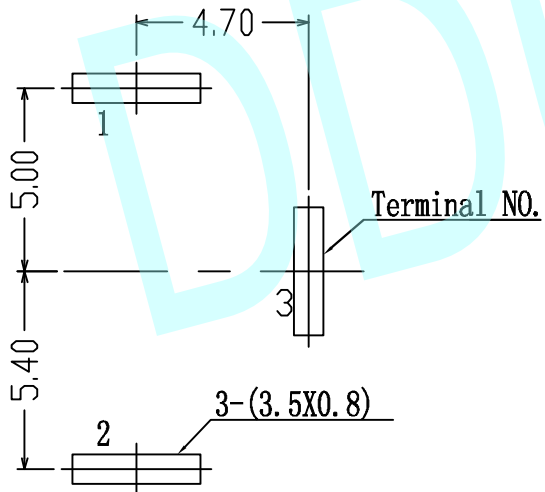

PCB Layout (Copper-Side View)

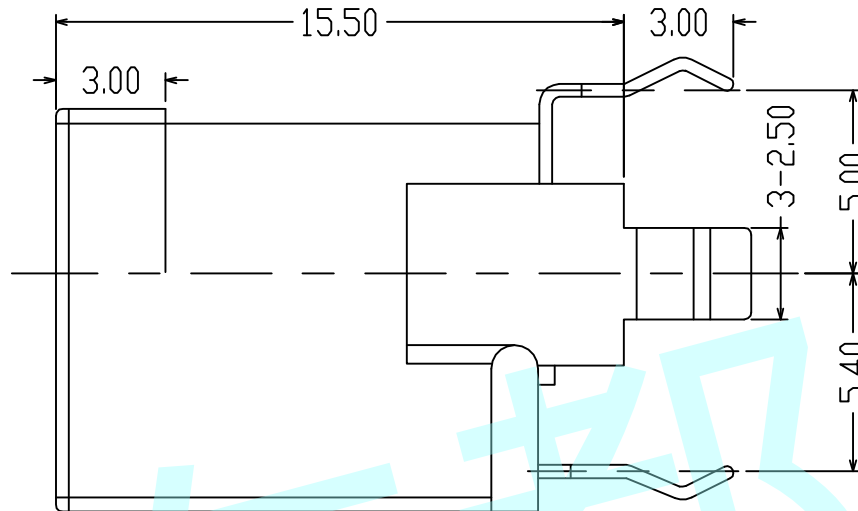
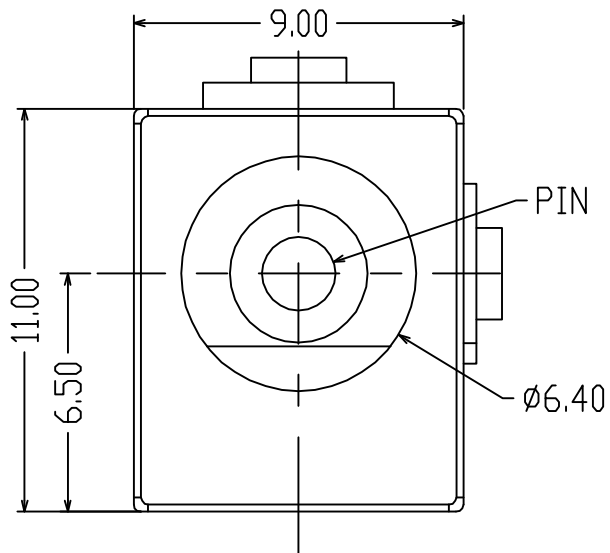
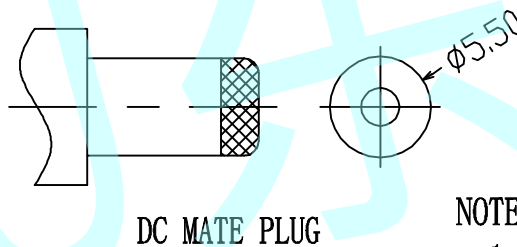

DC MATE PLUG

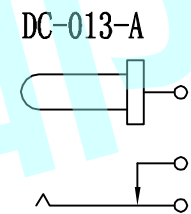

DC-013-A

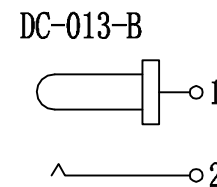

DC-013-B

CIRCUIT DIAGRAM

NOTES:

1. Rating: 0.5A 30V DC
2. Contact Resistance: 100mΩ Max.
3. Operating temperature: -20°C ~ 70°C
4. Operating force: 3-20N
5. Operating Life: 5,000cycles

		PIN	ø2.00	ø2.35	ø2.50
APPROVALS	DATE	http://www.dongdudz.com			
DRAW:	ZRD	2017-12-6	TOLERANCE:	ANGLE:	±2°
CHECKED:	***	***	30° ≥ ±0.30	±2°	
APPOVALS:	***	***	10°~30 ±0.20		
			5°~10 ±0.15		
			≤5 ±0.10		
APPROVALS		DATE	http://www.dongdudz.com		 ® 东都电子 DONGDU ELECTRONICS
DRAW:	ZRD	2017-12-6	TOLERANCE:	ANGLE:	
CHECKED:	***	***	30° ≥ ±0.30	±2°	
APPOVALS:	***	***	10°~30 ±0.20		
			5°~10 ±0.15		
			≤5 ±0.10		
MODEL:	DC POWER JACK				
PART NO:	DC-013				
UNIT :mm	SCALE: 1:1				
REV:	A			PAGE: 1/1	