

ROHS

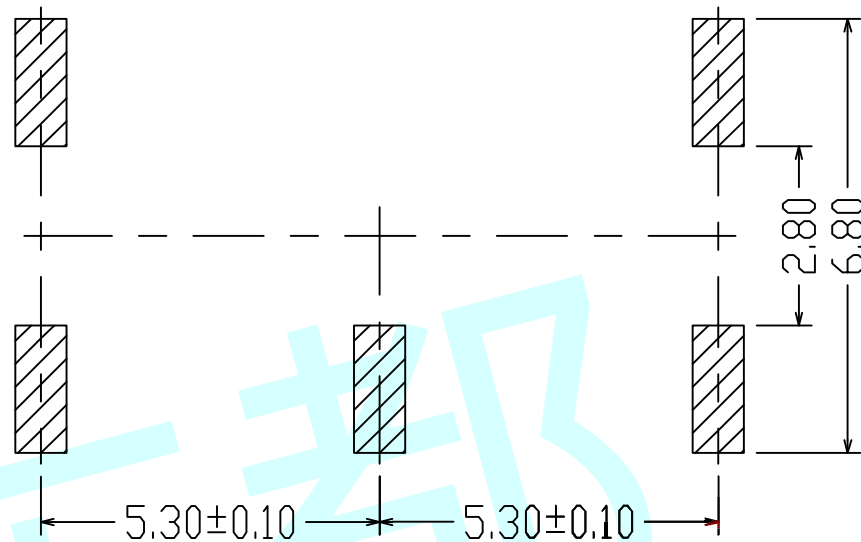

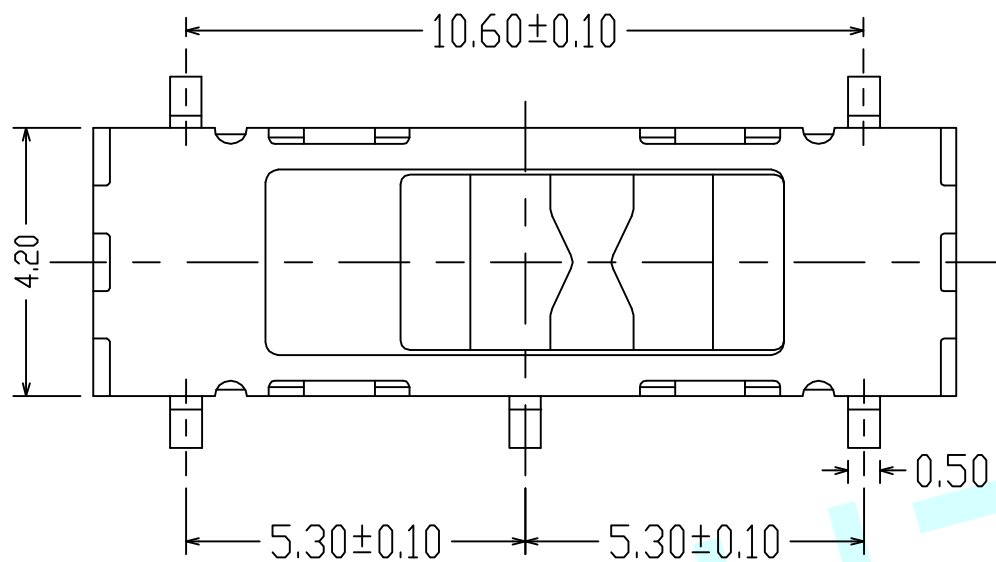

PCB Layout (Pattern Side)

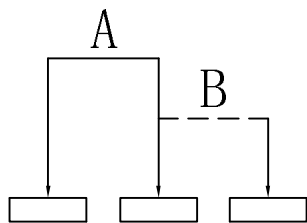
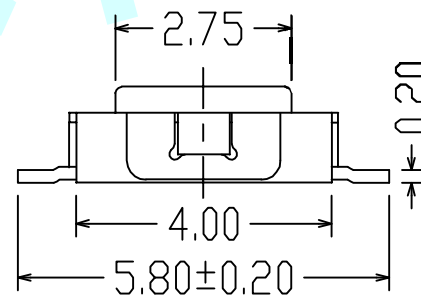
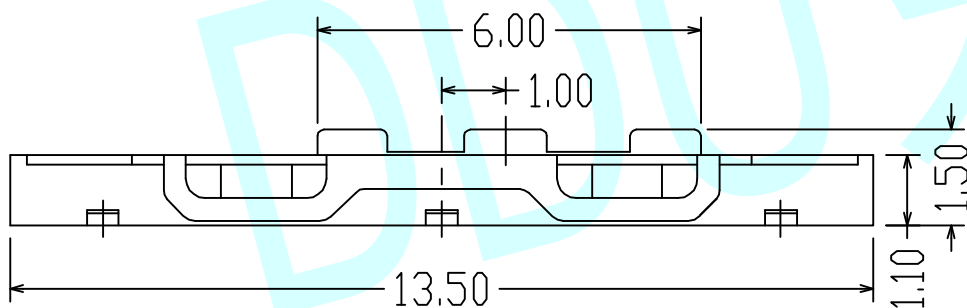

Circuit Diagram

NOES:

1. Operating Force: 130 ± 50 gf
2. Travel: 2.00mm

APPROVALS		DATE	http://www.dongdudz.com		 ® 东都电子 DONGDU ELECTRONICS	
DRAW:	ZRD	2017-12-6	TOLERANCE:	ANGLE:		
CHECKED:	***	***	30° ≥	±0.30		±2°
APPOVALS:	***	***	10° 30	±0.20		
			5° 10	±0.15		
			≤5	±0.10	MODL: TOGGLE SWITCHES PART NO: DDU-1422S UNIT :mm SCALE: 1:1  REV: A PAGE: 1/1	