

ROHS

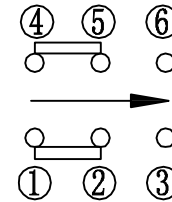

Circuit Diagram

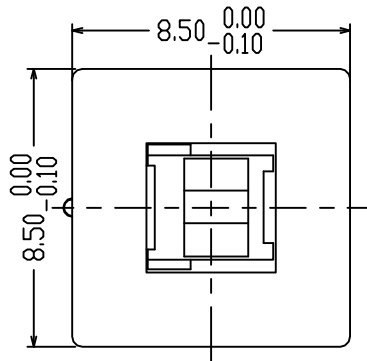

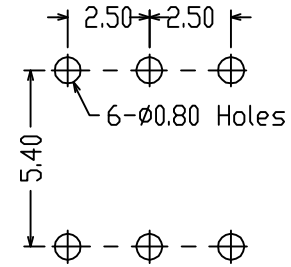

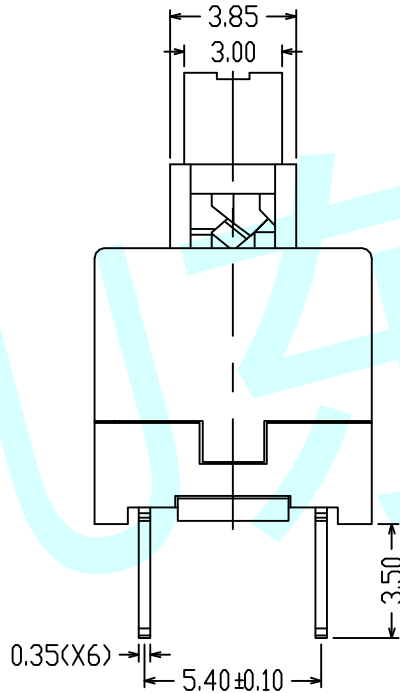
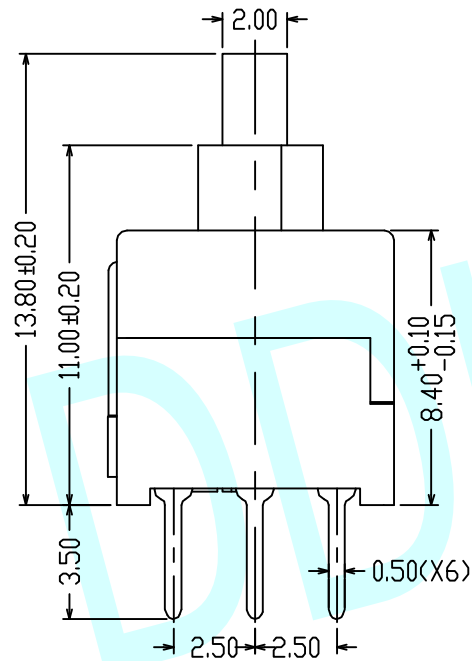
PCB Layout (Pattern Side)

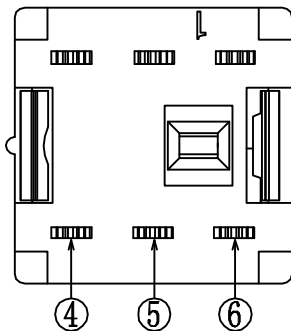
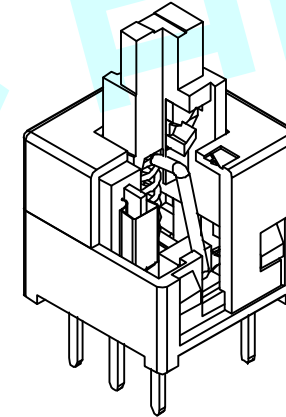

NOTES:

1. Operating Force : 240gf ± 80gf
2. Travel: 2.40 ± 0.30mm



APPROVALS		DATE	http://www.dongdudz.com		 ® 东都电子 DONGDU ELECTRONICS
DRAW:	ZRD	2017-12-6	TOLERANCE:	ANGLE:	
CHECKED:	***	***	30°	± 0.30	± 2°
APPOVALS:	***	***	10°30'	± 0.20	
			5°10'	± 0.15	
			≤ 5	± 0.10	
MODEL:	PUSHBUTTON SWITCHES		UNIT: mm	SCALE: 1:1	
PART NO:	DDU-1301		REV:	A	PAGE: 1/1