

**ROHS**

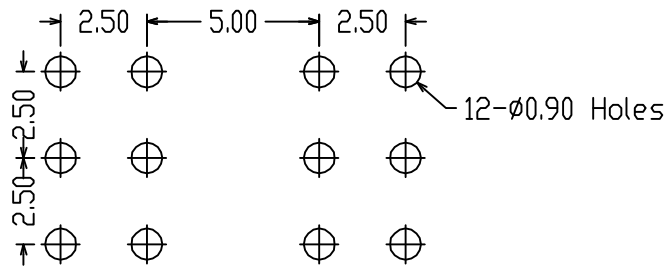

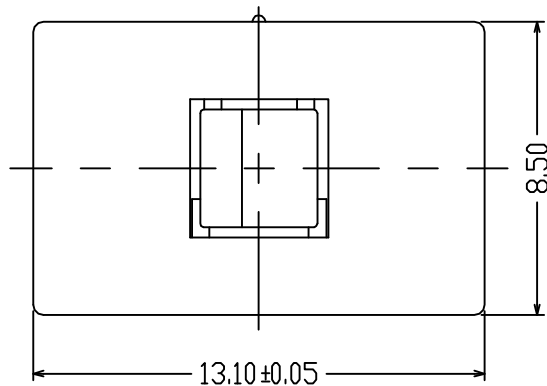

PCB Layout (Pattern Side)

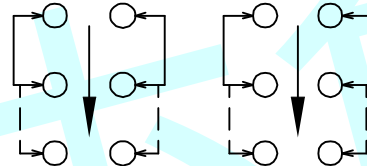
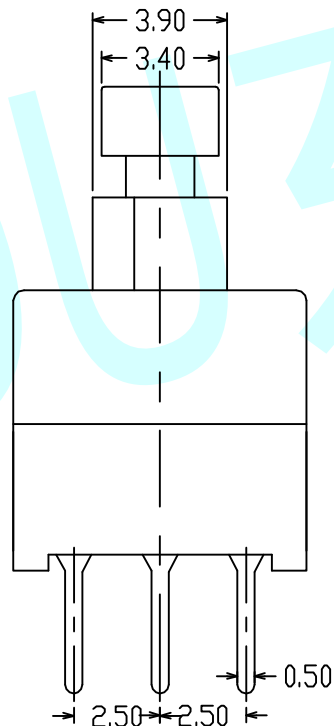
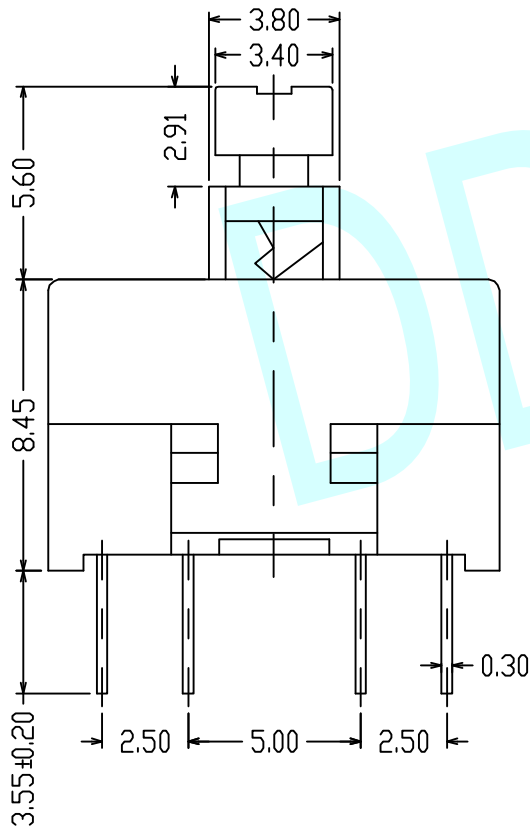

Circuit Diagram

**NOTES:**

- 1. Operating Force : 400gf ± 80gf
- 2. Travel : 2.50 ± 0.30mm

APPROVALS		DATE	http://www.dongdudz.com	
DRAW:	ZRD	2017-12-6	TOLERANCE:	ANGLE:
CHECKED:	***	***	30°	±0.30
APPOVALS:	***	***	10°30'	±0.20
			5°10'	±0.15
			≤5	±0.10
			±2°	
			 <b>® 东都电子</b> DONGDU ELECTRONICS	
			MODEL: PUSHBUTTON SWITCHES PART NO: DDU-1307 UNIT :mm SCALE:1:1  REV: A PAGE:1/1	