

ROHS

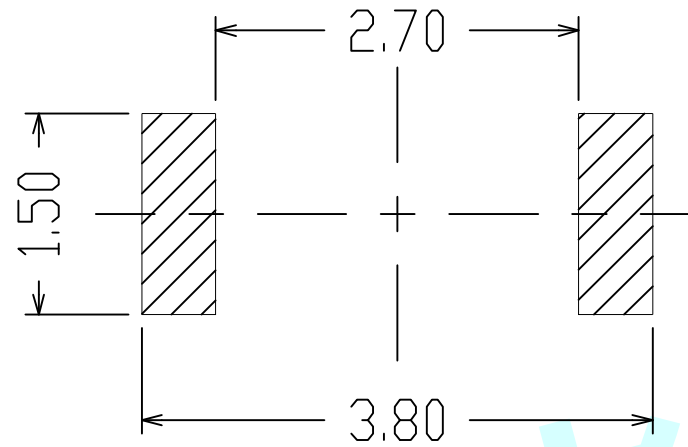

PCB Layout (Pattern Side)

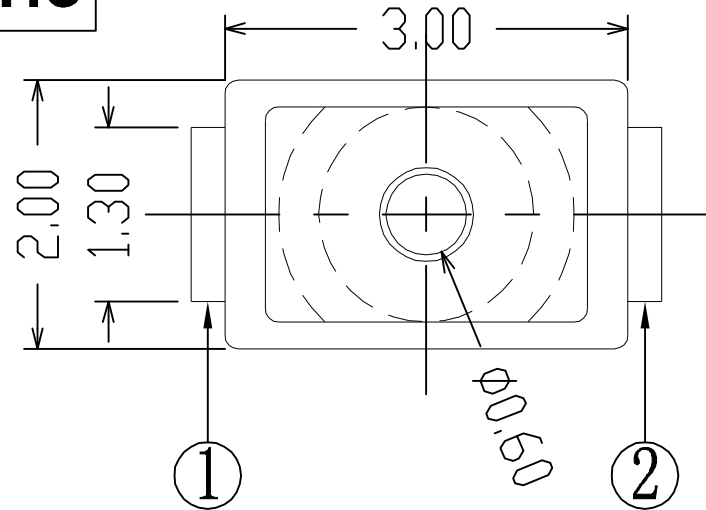

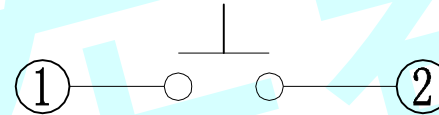
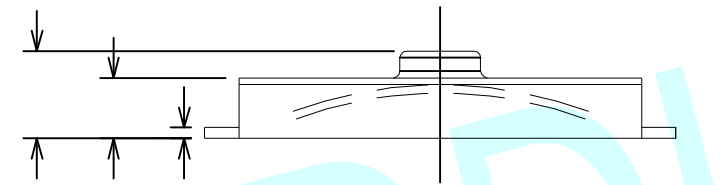

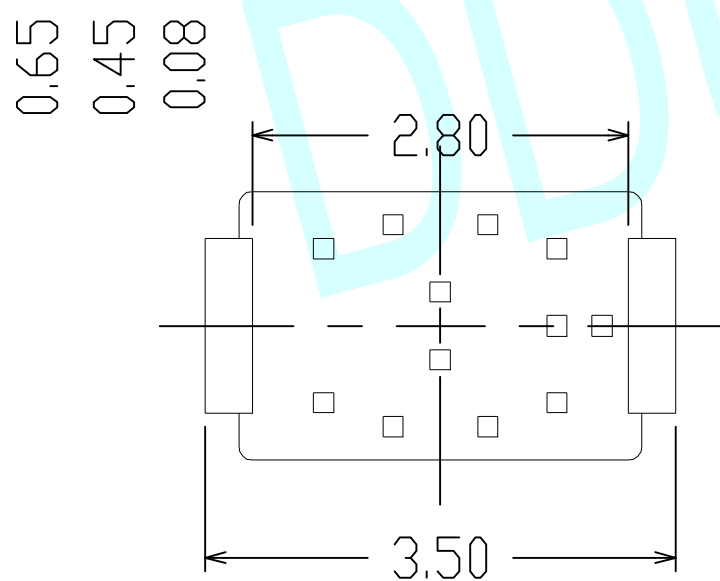
Circuit Diagram



NOTES :

1. Rating :DC 12V 50mA.
2. Contact resistance:  $\leq 50m\Omega$
3. Insulation resistance:  $\geq 100M\Omega$
4. Travel:  $0.15 \pm 0.05mm$

APPROVALS		DATE	http://www.dongdudz.com		 <b>® 东都电子</b> DONGDU ELECTRONICS	
DRAW:	ZRD	2017-12-6	TOLERANCE:	ANGLE:		
CHECKED:	***	****	30° $\geq$	$\pm 0.30$		$\pm 2^\circ$
APPOVALS:	***	****	10°30	$\pm 0.20$		
			5°10	$\pm 0.15$		
			$\leq 5$	$\pm 0.10$		
MODEL:	TACT SWITCHES		UNIT :mm	SCALE: 1:1		
PART NO:	DDU-1118Q		REV:	A	PAGE: 1/1	