

ROHS

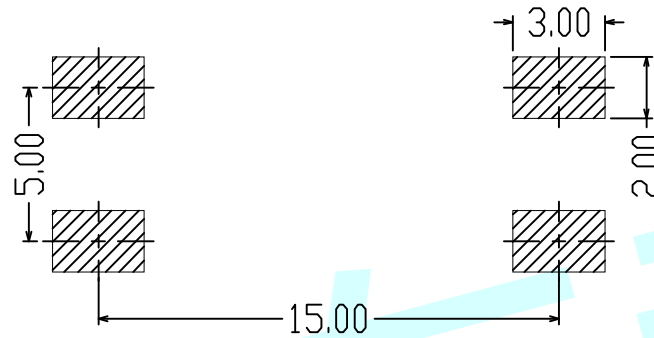

PCB Layout (Pattern Side)

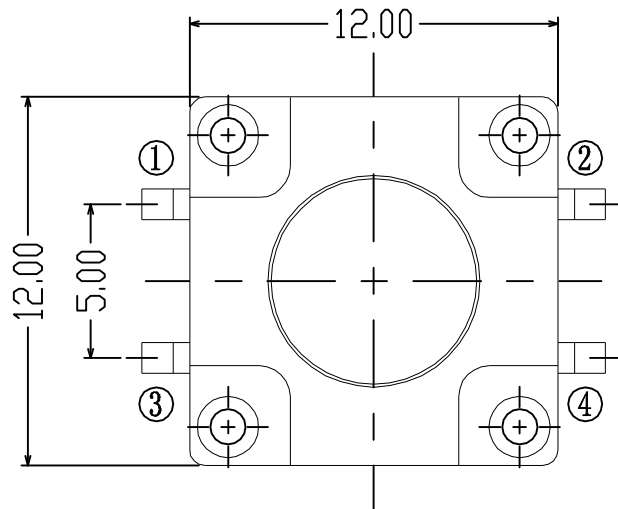

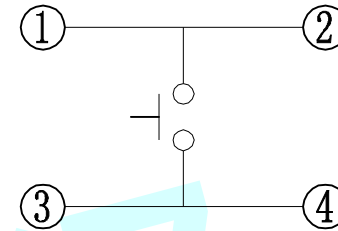

Circuit Diagram

NOTES :

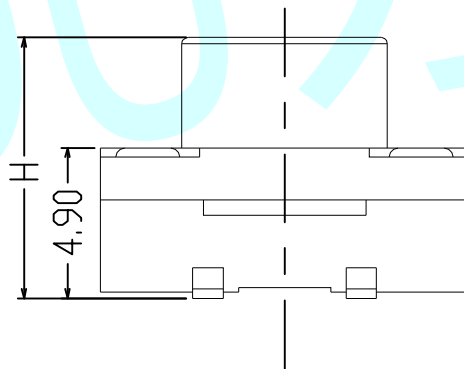
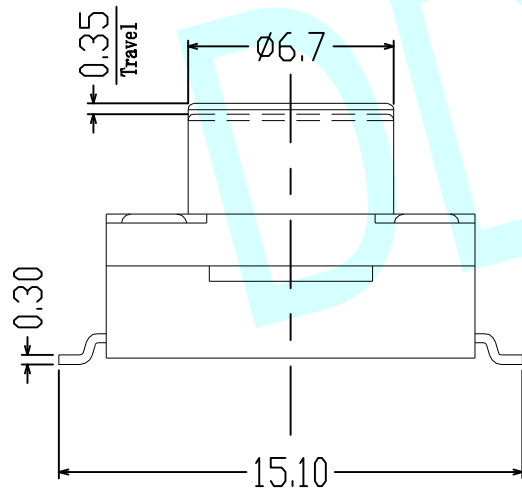
1. Rating :DC 12V 50mA.
2. Contact resistance: $\leq 100m\Omega$
3. Insulation resistance: $\geq 100M\Omega$
4. Waterproof grade: IP67
5. Life :100,000 Cycles



H	11.0	11.5	12.0	12.5	13.0	13.5	14.0	15.0	15.5	16.0	16.5	17.0	18.0	19.0
	4.3	4.5	5.0	5.5	6.0	6.5	7.0	7.5	8.0	8.5	9.0	9.5	10.0	10.5

APPROVALS		DATE	http://www.dongdudz.com		 ® 东都电子 DONGDU ELECTRONICS	
DRAW:	ZRD	2017-12-6	TOLERANCE:	ANGLE:		
CHECKED:	***	****	30° \geq	± 0.30		±2°
APPOVALS:	***	****	10°30	± 0.20		
			5°10	± 0.15		
			≤ 5	± 0.10		
MODEL:	TACT SWITCHES		PART NO:	DDU-1143S		
UNIT :mm	SCALE: 1:1					
REV:	A			PAGE: 1/1		